

# XTOOL | Safety Set

Gebruikershandleiding

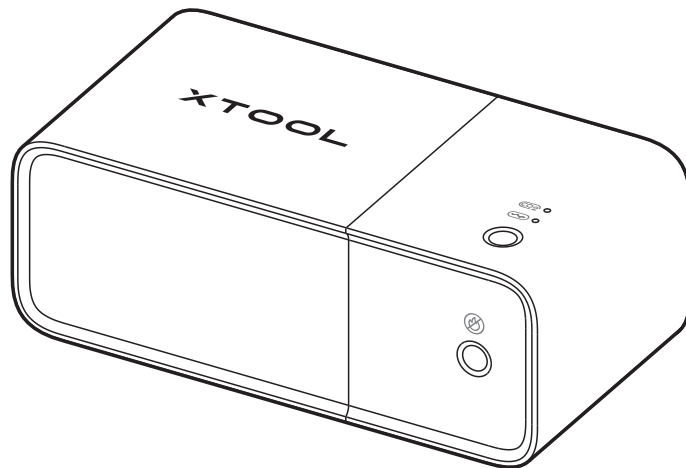

<b>Overzicht</b>	<b>01</b>
<b>Specificaties</b>	<b>01</b>
<b>Lijst van onderdelen</b>	<b>02</b>
<b>Leer de brandbeveiligingsset kennen</b>	<b>03</b>
<b>De brandbeveiligingsset installeren</b>	<b>04</b>
<b>CO<sub>2</sub>-patronen installeren</b>	<b>04</b>
<b>De brandbeveiligingsset gebruiken</b>	<b>06</b>
<b>Met een druk op de knop brand blussen</b>	<b>07</b>
<b>CO<sub>2</sub>-patronen vervangen</b>	<b>08</b>

## Overzicht

Dit product is een accessoire ontworpen voor desktop laserbewerkingsmachines die vlammen kunnen detecteren. Als het signalen ontvangt van een lasermachine die duiden op een grote vlam, start en voltooit het automatisch het blusproces.

## Specificaties

Werktemperatuur	0°C–35°C
Opslagtemperatuur	0°C–45°C
Max. ondersteunde werkruiimte	0,13 kubieke meter

## Lijst van onderdelen

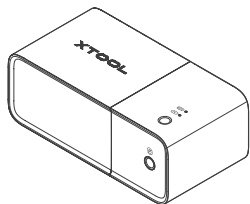

Regelkastje

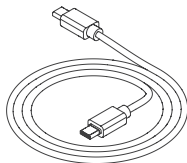

USB-kabel

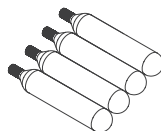

CO<sub>2</sub>-patroon

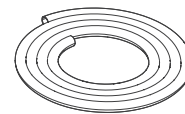

Buis

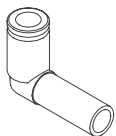

Buisadapter



Gebruikershandleiding



Veiligheidsinstructies

## Leer de brandbeveiligingsset kennen

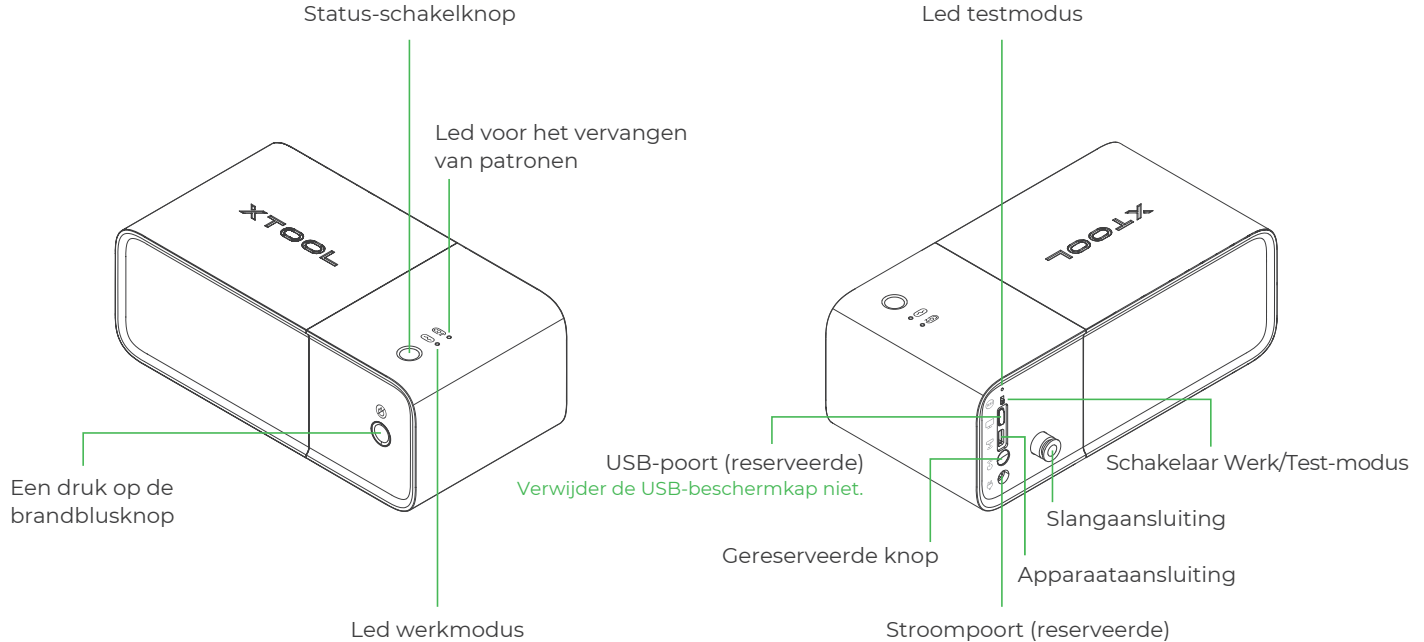

## De brandbeveiligingsset installeren

Afhankelijk van de laserbewerkingsmachines kan de brandbeveiligingsset variëren.

Als u een xTool-machine gebruikt, ga dan naar [support.xtool.com/product/17](https://support.xtool.com/product/17) om de volgende QR-code te scannen voor meer informatie over de installatie van de brandbeveiligingsset.



[support.xtool.com/product/17](https://support.xtool.com/product/17)

## CO<sub>2</sub>-patronen installeren



Koppel de USB-kabel los voordat je CO<sub>2</sub>-flessen installeert. Anders raak je mogelijk per ongeluk de knop voor eenmalig blussen om de bluswerking in gang te zetten.

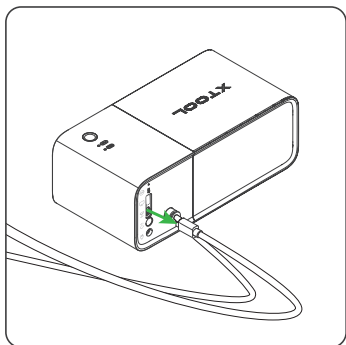

Koppel de USB-kabel los

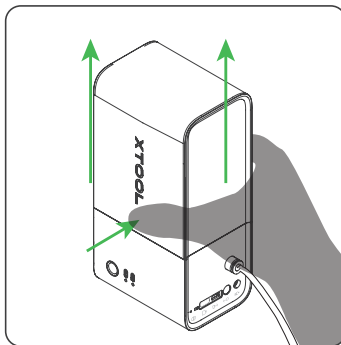

Knijpen en trekken

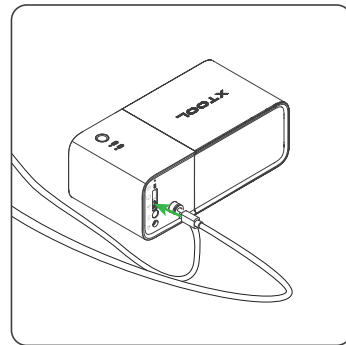
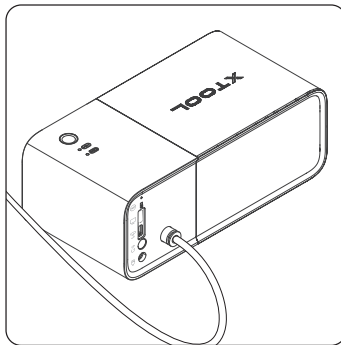
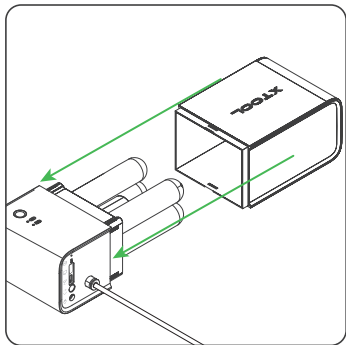
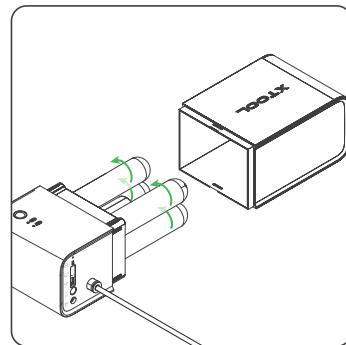

Koppel de USB-kabel aan

## De brandbeveiligingsset gebruiken

### Werkstatus invoeren

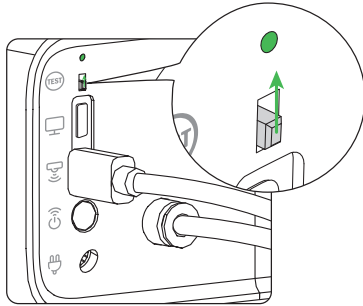

Beweeg de schakelaar naar boven om de werkmodus in te schakelen

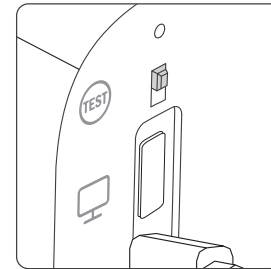

Uitgaan

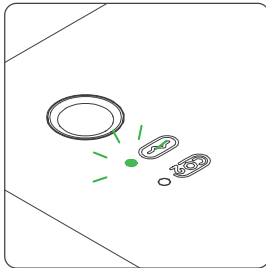

Knipperend

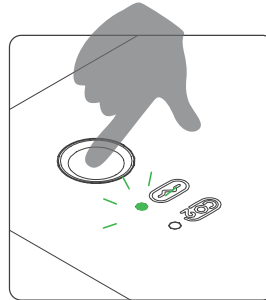

Druk

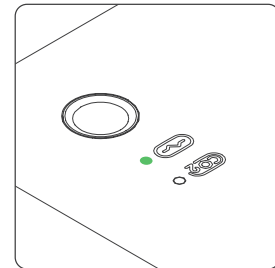

Onafgebroken groen: komt in bewakingsmodus



## Met een druk op de knop brand blussen

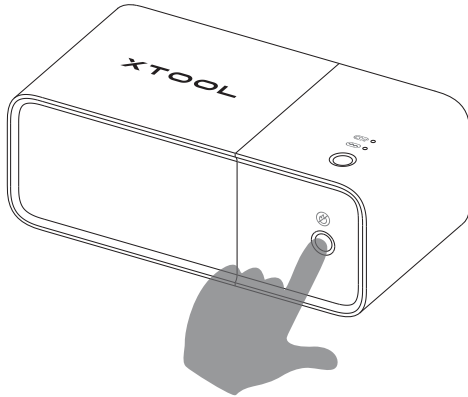

Als de brandbeveiligingsset in de werkmodus is, activeert u de brandblusactie met een druk op de knop.

Tijdens het blussen komt het gas tweemaal vrij met een tussenpose van 20 seconden. Wacht tot het proces voltooid is voordat u het regelkastje gebruikt.

Voer deze actie voorzichtig uit. De brandblusactie kan niet ongedaan worden gemaakt.

## CO<sub>2</sub>-patronen vervangen



- Na het uitvoeren van de brandblusactie blijft de led die aangeeft dat gaspatronen vervangen moeten worden onafgebroken branden. Dit betekent dat u de gaspatronen moet vervangen. Ter vervanging moet u nieuwe gaspatronen kopen.
- Koppel de USB-kabel los voordat je CO<sub>2</sub>-flesjes vervangt. Anders raak je mogelijk per ongeluk de knop voor eenmalig blussen om de bluswerking in gang te zetten.

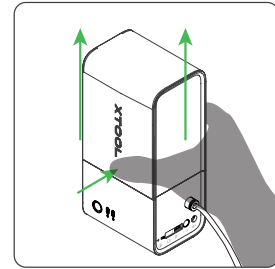
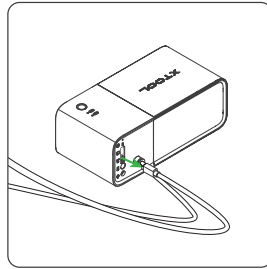
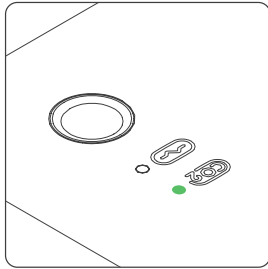

Knijpen en trekken

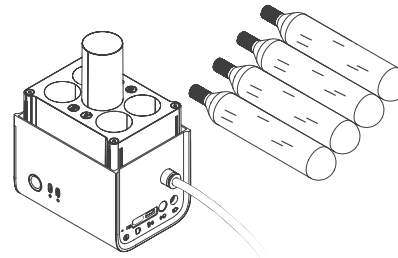
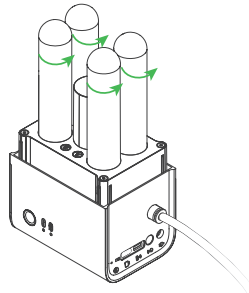

- Als de omsloten werkruimte niet groter is dan 0,065 kubieke meter, kunt u kiezen om 2 of 4 gaspatronen te vervangen.

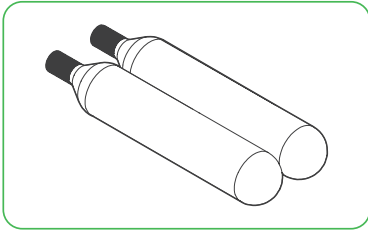

Als u 2 patronen gebruikt, installeert u ze diagonaal, bijvoorbeeld in de A-openingen. U installeert dan twee lege patronen op de andere diagonaal.

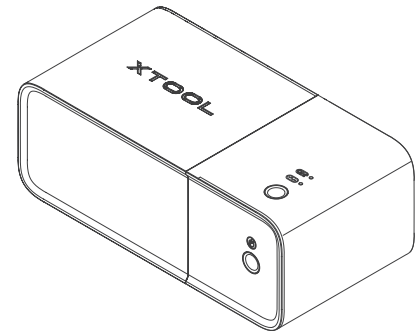
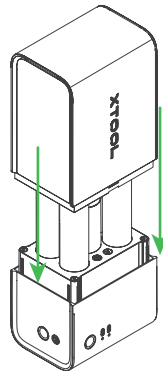
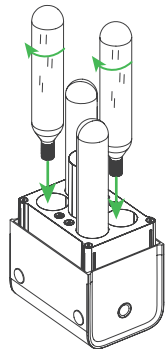
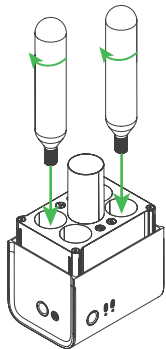

■ Als de omsloten werkruimte groter is dan 0,065 kubieke meter, maar niet groter dan 0,13 kubieke meter moet u 4 gaspatronen vervangen.

